

Section 4: Configuration & Connection

4.1 INPUT CONNECTION EXAMPLES

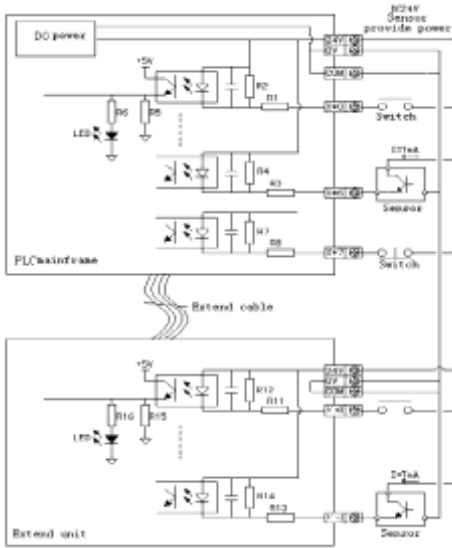

4.2 OUTPUT CONNECTION EXAMPLES

Relay output example

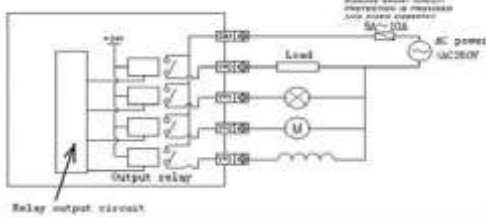

Transistor output example

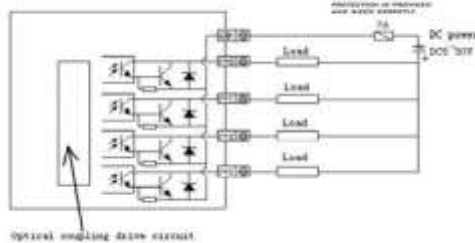

Documentation Reference

Document Number	Revision Date
-----------------	---------------

Cuts	XC5	R3	V1	07/09/2011
------	-----	----	----	------------

XINJE IS A REGISTERED TRADEMARK OF XINJE ELECTRICAL CO.LTD. REPLICATION OF THE INFORMATION CONTAINED WITHIN THIS DOCUMENT WITHOUT PRIOR NOTIFICATION AND AGREEMENT IS PROHIBITED.

Section 1: Installation General

The XC5 series requires configuration, setup and installation by competent persons. The instructions contained within this document are for technically competent persons. Failure to follow instructions within this document may result in harm or injury.

1.1 ENVIRONMENTAL REQUIREMENTS

The units location and installation shall be in accordance with the following:-

- ⇒ Free from wet and condensation.
- ⇒ Away from corrosive gases and dusts.
- ⇒ In area free from liquids or chemicals.

1.2 WIRING

The unit shall be wired and connected taking account of the following:

- ⇒ Away from high voltage, mains power supplies or cables with high currents.
- ⇒ Never connect to voltages outside those specified and ensure the polarity of supply is correct.
- ⇒ All connections should be in accordance with the connection diagrams within this document.
- ⇒ Ensure power cables are a minimum cross sectional area of 2mm² to avoid excessive voltage drop.
- ⇒ Ensure earth terminations of the base unit and extended modules are taken to a common earth point.

Section 2: Specifications

2.1 GENERAL SPECIFICATIONS

The following sections provide detailed specifications on the unit.

Item	Description
Insulated voltage	Up to 500V DC 2MΩ
Power consumption	≤15 W
Voltage endurance	AC1000V 1uS pulse per
Ambient temperature	0~60°C
Ambient Humidity	5~95% (no condensation)
Anti-jamming	voltage noise 1000V 1pS per minute
Protection level	accord with IP65F
Environment	non-corrosive gas or liquid
COM1	RS-232, connect with host machine, HMI program or debug
COM2	RS-232/RS-485, connect with network or aptitude instrument, inverters etc.
COM 3	BD board COM port RS-232C/RS-485
Installation	Can use M3 screw to fix or install directly on DIN46277 (Width 35mm) orbit
Grounding	The third type grounding (can't public ground with strong power system.)

Note:

1. To avoid voltage decrease, please use the power cable thicker than 2mm²
2. Even appear power cut within 10ms, PLC can still go on working. But if long time power cut or abnormal power decrease, PLC will stop working, output will also appear OFF status, when recover power supply, the PLC will auto start to work.
3. Connect the grounding terminals of basic units and extend modules together, then ground

Section 2: Specifications cont....

2.2 POWER SPECIFICATIONS

Item	Description	DC power type
Rated voltage	AC220V	DC24V
Voltage allow bound	AC90V~265V	DC21.6V~26.4V
Rated frequency /Input current (base unit)	50/60Hz	120mA DC24V
Allow momentary power-cut time	Interrupt time ≤0.5 AC cycle, alternation ≥1 sec	10mS DC24V
Impact current	Max 40A 5mS below/AC100V max 60A 5mS below/AC2000V	10A DC26.4V
Max power consumption	12W	
Power for sensor use	24VDC±10% max 400mA	

2.3 INPUT SPECIFICATIONS

Item description	Parameter settings
Input signal 's voltage	DC24V±10%
Input signal 's current	7mA/DC24V
Input ON current	Up to 4.5mA
Input OFF current	Low than 1.5mA
Input response time	Approximately 10ms
Input signal 's format	Contact input or PNP open collector transistor
Circuit insulation	Optical coupling isolation
Input action 's display	LED lights when the input is ON

2.4 OUTPUT SPECIFICATIONS

Item	Relay output	Transistor output
Internal power	Below AC 250V DC30V	Below DC5~ 30V
Circuit insulation	Mechanism isolation	Optical coupling insulation
Action indicator	Indicate lamp LED	
Max load	Resistance load	3A 0.8A
	Induce load	80VA 12W/DC24V
	Lamp load	100W 1.5W/DC24V
Min. load	DC5V 2mA	
Response time	On/Off	10ms Below 0.2m s
	On/Off	10ms Below 0.2m s

Section 3: Dimensions

3.1 DIMENSION (UNIT: MM)

XC5 series 32 points main units

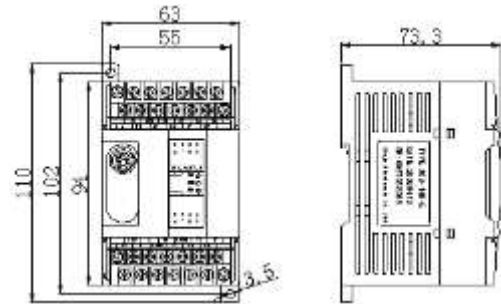

XC5 48/60 point

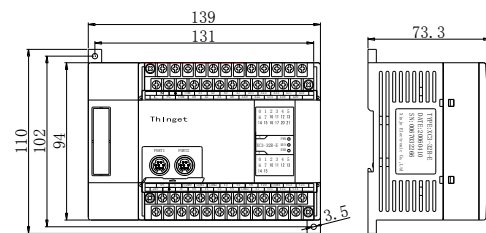

3.2 TERMINAL ARRANGEMENTS

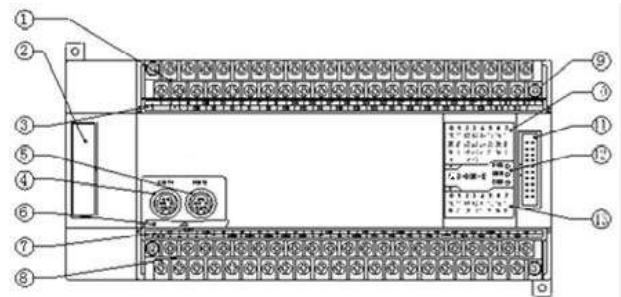

1. input terminal 2. BD expansion 3. Input label 4. COM port 5. COM port 6. COM port cover board 7. Output label 8. Output terminals 9. Screws 10. Input indicate 11. Extension port 12. Programming status indicate LED 13. Output indicate LED

3.3 COMMUNICATION PORT

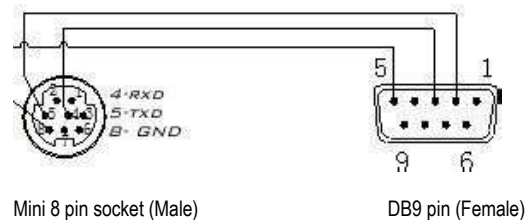

Mini 8 pin socket (Male)

DB9 pin (Female)

3.4 PROGRAM CABLE

Pins are as follows:

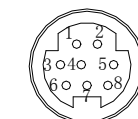

Mini Din 8 core socket (hole)

- COM1 COM2
- 2 : PRG 4 : RXD
- 4 : RXD 5 : TXD
- 5 : TXD 8 : GND
- 6 : VCC
- 8 : GND